

119G3565EN

SWING TURNSTILE

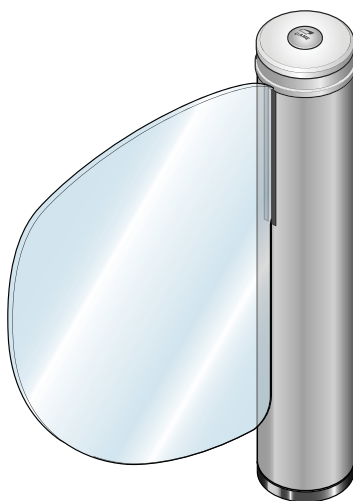

Installation manual

WING40



WARNING!

important safety instructions: READ CAREFULLY!



Foreword

• This product should only be used for the purpose for which it was explicitly designed. Any other use is considered improper and therefore dangerous. CAME Cancelli Automatici S.p.A. will not be held liable for damage caused by improper, incorrect or unreasonable use. • The safety of the product, and therefore its proper installation, depends on total compliance with the technical specifications and installation procedures, as well as with rules regarding safety and use, expressly mentioned in the technical documentation for the products themselves. • Keep these warnings together with the installation and operation manuals for the operator system components.

Before installing

(preliminary check: in case of a negative outcome, do not proceed until you have complied with the safety requirements)

- Installation and testing must only be performed by qualified personnel
- Cable routing, installation, connection and testing must be carried out to the highest levels of workmanship in accordance with applicable laws and regulations
- Before starting any operation, read all the instructions carefully; incorrect installation can be dangerous and harm persons or property
- Check that the operator is in good mechanical condition, balanced and aligned, and that it opens and closes properly. If needed, also install suitable guards or use appropriate additional safety sensors
- If the operator will be installed at a height of less than 2.5 m from the ground or other access level, check whether you will need any protections and/or warnings
- Check that opening the turnstile does not create a dangerous situation
- Do not mount the operator upside down or onto any elements that may fold under its weight. If needed, add suitable reinforcements at the points where it is secured
- Do not install on ground that is not level
- Check that any lawn watering devices will not wet the operator from the bottom up.

Installation

- Carefully section off the entire site to prevent unauthorised access, especially by minors and children
- Be careful when handling operators that weigh more than 20 kg. In such cases, use proper weight handling safety equipment
- CE safety devices (photocells, platforms, sensitive edges, emergency button etc.) must be installed in compliance with applicable legislation and according to the highest standards of workmanship, bearing in mind the environment, the type of service required and the operating forces applied to the moving turnstiles. Points where there is a risk of crushing, shearing or dragging must be protected using suitable sensors
- End users must be informed of any residual risks by means of special pictograms as envisaged by legislation
- All opening commands (buttons, key selectors, magnetic readers etc.) must be installed at least 1.85 m from the perimeter of the area of turnstile movement, or where they cannot be reached from outside through the turnstile. Also, the direct commands (buttons, touch commands etc.) must be installed at a height of at least 1.5 m and must not be accessible to the public
- The turnstile identification data must be clearly visible
- Before connecting the turnstile to the power supply, make sure the identification data corresponds to the mains data
- The turnstile must be connected to an effective, compliant earthing system.
- The manufacturer disclaims any liability for the use of non-original products; this also results in the invalidation of the warranty
- All 'hold-to-run' commands must be placed where the moving turnstile, transit areas and driveways are completely visible
- Before delivery to the user, check that the system complies with the EN 12453 and EN 12445 standards (impact tests), check that the operator has been properly adjusted and that the safety and protective devices work correctly
- As appropriate and in a visible position, affix warning symbols.

Special instructions and advice for users

- Keep the turnstile's area of operation clean and clear of any obstacles. Check that the photocells' area of operation is free from obstacles
- Children must be supervised to make sure they do not play with the operator and the fixed control devices or stand in the turnstile's area of operation. Keep any remote control devices (i.e. transmitters) or any control devices away from children as well, to prevent the operator from being activated accidentally
- The operator is not designed to be used by persons (including children) whose physical, sensorial or mental capacities are limited, or who are lacking in experience or knowledge, unless

said persons can be supervised or given instructions regarding using the operator by a person responsible for their safety

- Frequently check the system, to see whether any anomalies or signs of wear and tear appear on the moving parts, on the component parts, on the securing points, on the cables and any accessible connections. Keep any joints lubricated and clean, and do the same where friction may occur
- Perform functional tests on photocells every six months. Ensure that the glass on the photocells is kept clean (use a cloth slightly moistened with water; do not use solvents or any other chemicals as these could damage the devices)
- If the system requires repairs or modifications, disconnect the power to the operator and do not use it until safety conditions have been restored
- Cut off the electrical power supply for manual opening. Read the instructions
- If the power cable is damaged, it must be replaced by the manufacturer or the technical assistance service or by a person with a similar qualification so as to prevent any risks
- It is STRICTLY FORBIDDEN for users to perform OPERATIONS THEY ARE NOT EXPLICITLY REQUIRED AND ASKED to do. For repairs, adjustments and extraordinary maintenance, CONTACT THE SPECIALIST TECHNICAL SERVICE CENTRE. On the periodic maintenance log, note down the checks you have done.

Further special instructions and advice for all

- Avoid working near the turnstiles or moving mechanical parts
- Stay clear of the turnstile's area of operation when in motion
- Do not resist the direction of movement of the operator; this may present a safety hazard
- At all times be extremely careful about dangerous points that must be indicated by proper pictograms and/or black and yellow stripes
- When using a selector or command in 'hold-to-run' mode, keep checking that there are no people in the area of operation of the moving parts. Do this until you release the command
- The turnstile may move at any time without warning
- Always cut the power when cleaning or performing maintenance.

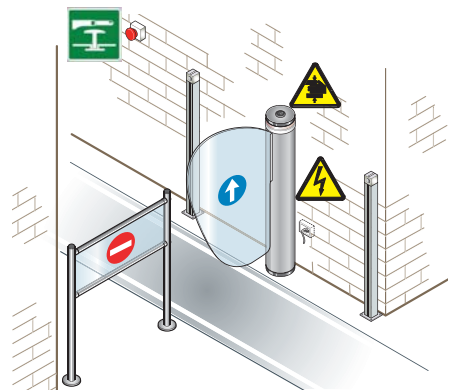

Hand crushing hazard





Danger high voltage



Emergency button

Legend

-  This symbol highlights parts which must be read with care.
-  This symbol highlights the parts which describe safety issues.
-  This symbol highlights the things to tell the end-user.

Description

This product is engineered and built by CAME Cancelli Automatici S.p.A. in compliance with current applicable safety laws. Automated bidirectional swing-wing turnstile, with body and upper cover made of stainless steel with scotch-brite finish. Either Plexiglas or tempered glass wing-barrier.

The wing-barrier opening, in either direction, can be activated by a card reader, photocells or other command device. The 90° wing-barrier opening speed is pre-set.

The wing-barrier's closing can be automatic (it closes after a set time) or activated by the command device.

The operator is SELF-LOCKING thanks to its built in electrical brake that locks it in place, thus allowing access only to authorised users. The operator reverts to reversible mode during black-outs to allow manual opening.

The complete range:
 001PSWNG40 - Automated, bi-directional, swing-wing turnstile.

Complementary accessories:
 001PSWL60 - Plexiglas wing-barrier - width 600 mm;
 001PSWL90 - Plexiglas wing-barrier - width 900 mm;
 001PSWL60C - Tempered glass wing-barrier - width 600 mm;
 001PSWL90C - Tempered glass wing-barrier - width 900 mm.

Packing list

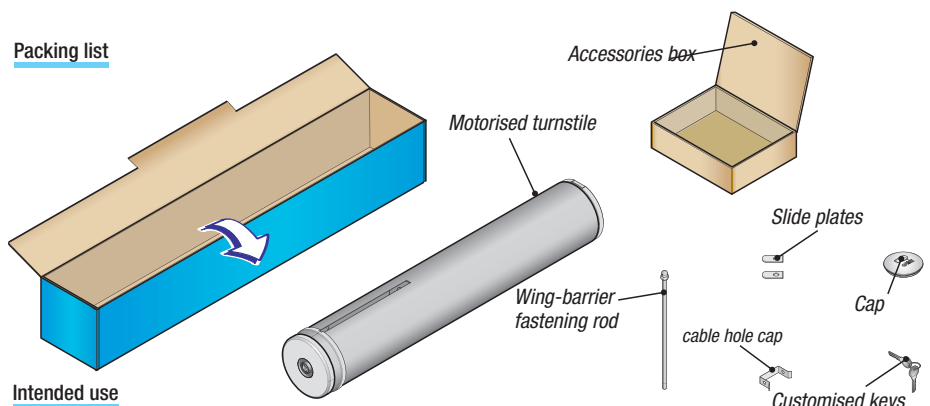

Intended use

The automated, swing-wing turnstile is engineered for controlling flows of pedestrian traffic in high-density settings such as in shopping malls, supermarkets, gyms and all facilities where regulating/selecting pedestrian traffic flows is a required.

 Any installation and use other than that specified in this manual is forbidden.

Operational limits

The maximum width of the wing-barrier is 900 mm weighing 15 Kg.

Technical data

Type	001PSWNG40
Protection rating	IP40
Power supply	230 V AC (50/60 Hz)
Motor power supply	24 DC (50/60 Hz)
Power draw on standby	350 mA
Power rating	120 W
Working temperature (°C)	-20 ÷ +55
Insulation class	II
Weight (Kg)	24 kg

Main component parts

1. Outer lining tube
2. Wing-barrier
3. Cover door lock
4. Top cap
5. Central column
6. Anchoring base
7. Electronic board with support
8. Deflector
9. Slide ring
10. Drive shaft
11. Mechanical limit-switch
12. Cable tube
13. Centering pin
14. Drag plate
15. Lock extender
16. Cover hooking bracket

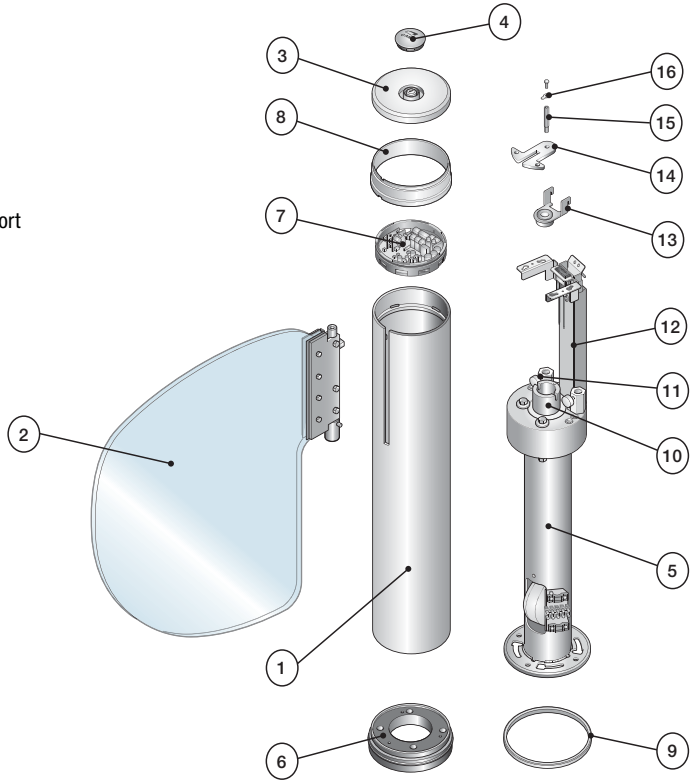

Dimensions

(mm)

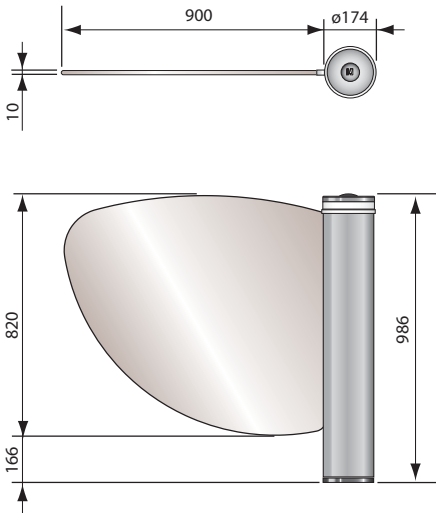

001PSWNG40 + 001PSWL90C / 001PSWL90

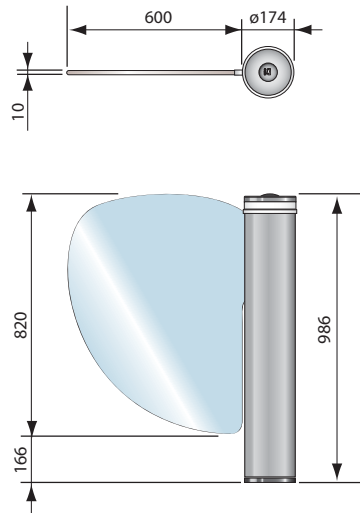

001PSWNG40 + 001PSWL60C / 001PSWL60

System feasibility

- ⚠ Installation must be carried out by skilled, qualified technicians in accordance with current regulations.

Preliminary checks

- ⚠ Before beginning to install, the following is necessary:
 - Set up a suitable omnipolar cut-off device, with distances greater than 3 mm between contacts, with sectioned power source;
 - Set up proper conduits and electric cable raceways, making sure these are protected from any mechanical damage;
 - ⚡ Check that any connections inside the container (made to ensure continuity in the protective circuit) are fitted with more insulation than other internal conductive parts;
 - Make sure the entrance way is in a proper state and level;
 - Section off the installation zone when mounting, and set up an alternative passage.

Tools and equipment

Make sure you have all the tools and materials needed to carry out the installation in total safety and in accordance with current regulations. The figure shows some examples of the tools needed by installers.

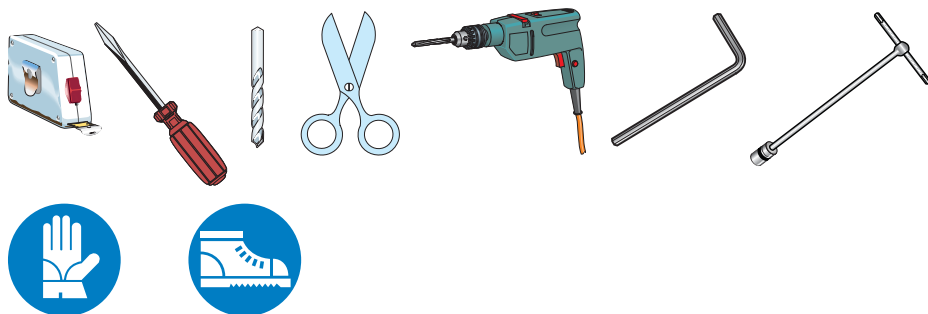

Types and minimum cable thicknesses

Connection for	Cable type	Cable length 1 < 20 m	Cable length 20 < 30 m
Power supply to control panel	FROR CEI 20-22	2 x 1.5 mm ²	2 X 1.5 mm ²
Safety and command devices	CEI EN 50267-2-1	2 x 0.5 mm ²	2 x 0.5 mm ²
Control devices (RBM84-CRP)	CAT 5 -U/UTP - AWG 24	1000 m max.	
Combined connection	CAT 5 -U/UTP - AWG 24		

N.B.: If cables are of a different length than that shown in the table, determine the cable section based on the actual draw and the number of connected devices and according to what is set forth in the IEC EN 60204-1 code of regulations.

For connections featuring several loads on the same line (i.e. sequential ones), the dimensions shown on the table must be reconsidered according to the total draw and actual distances. When connecting products not mentioned in this manual, only refer to the literature accompanying such products.

Standard installation

1. Swing turnstile
2. Command device
3. Safety barrier
4. Junction box
5. Emergency cut-off button

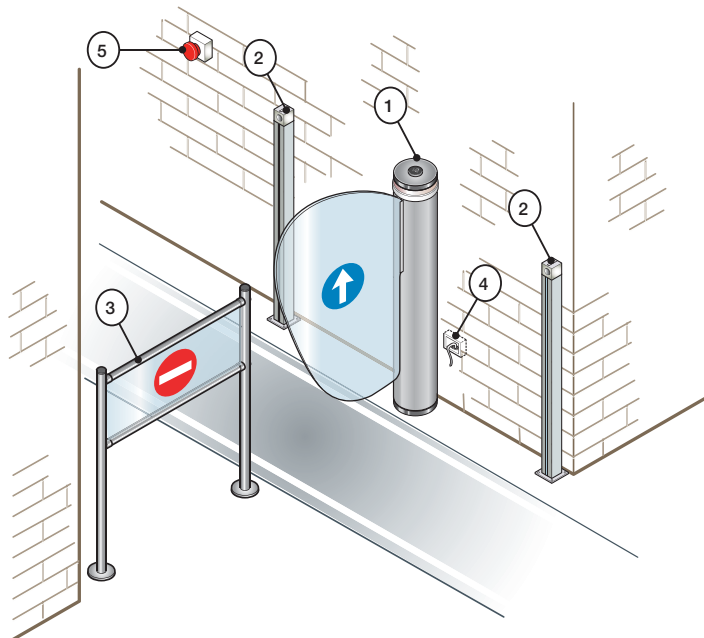

Application examples

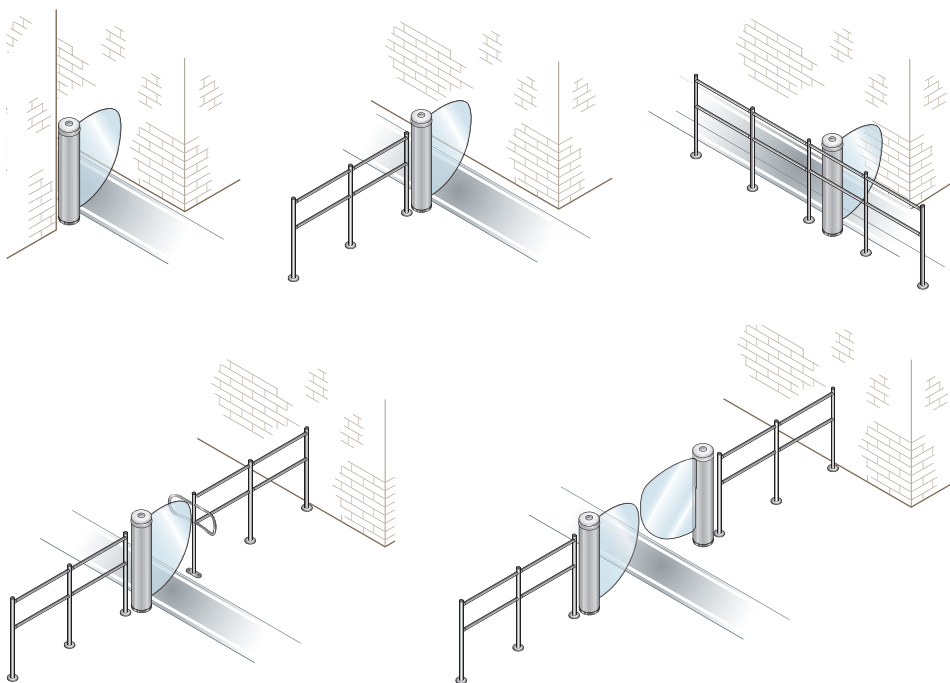

Installation

⚠ The following illustrations are just examples, in that the space for securing the operator and accessories depends on the installation zone. It is the installer's responsibility to choose the most suited solution.

⚠ Warning! Use hoisting equipment to transport and position the turnstile. During the pre-mounting and fastening phases, the turnstile could be unstable and there is a risk it could tip over. So be careful to not lean against the turnstile until it is completely mounted.

Preliminary operations

Remove the cover with the key.

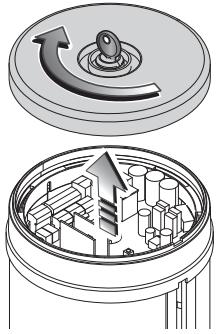

Remove the deflector and the card support from the tube.

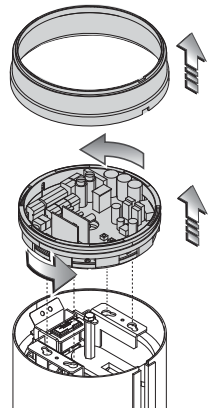

Remove the screws from the drag plate.

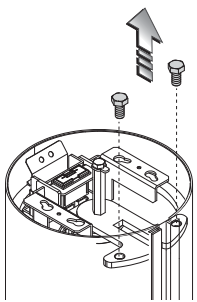

Remove the plate, the centering pin and lock extender and separate them.

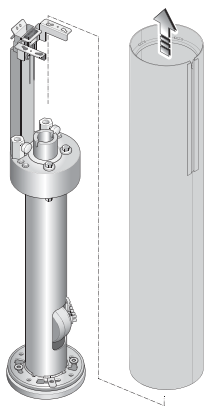
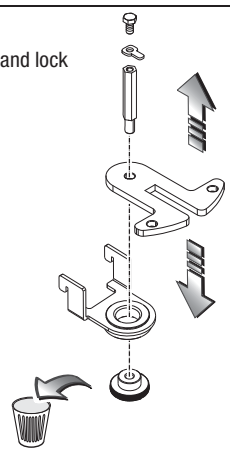
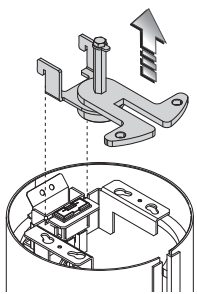

Slip the tube out of the central column.

Separate the base and slide ring from the column by removing the screw and washer.

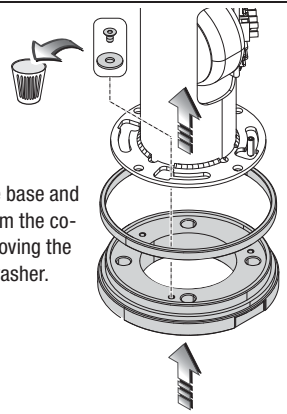

Setting up and anchoring the base to the ground

Check that there are no dips on the ground where you will anchor the turnstile.

Position the anchoring base as shown in the drawing (the gate wing is perpendicular to the wall). Use a pencil to mark anchoring holes.

Note: when installing near wall, respect the 400 mm minimum distance.

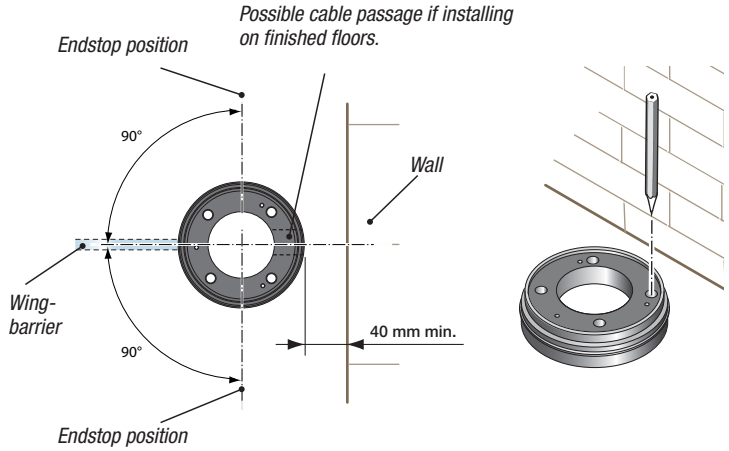

Perforate where marked.

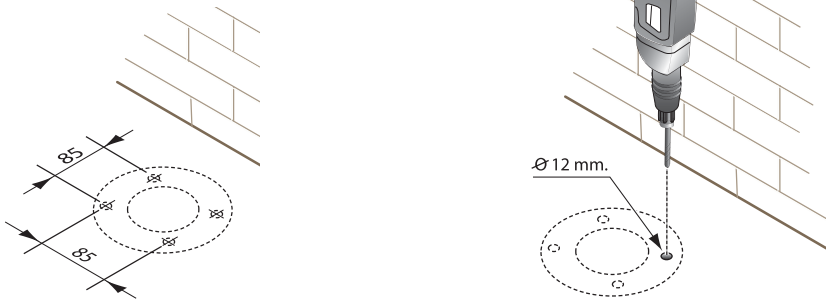

Set up corrugated tubes for cable to go through. Lay the cables through the tubing.

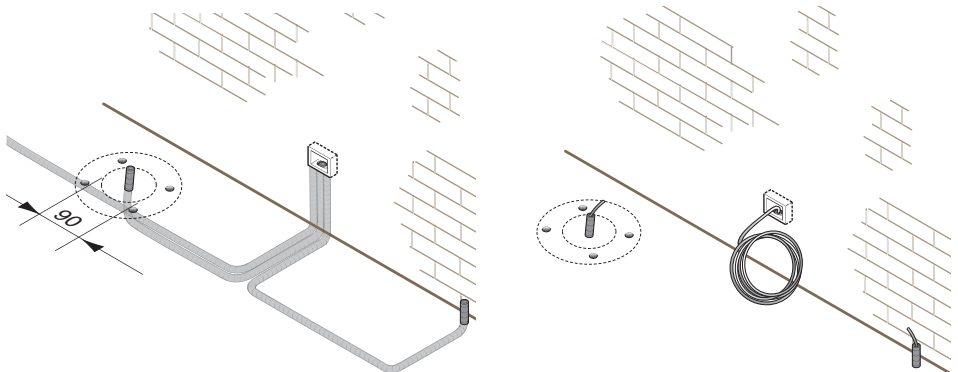

Anchoring the turnstile to the ground

Position the base onto the anchoring point and level it, if necessary, using the adjusting grub screws. Fit the slide ring and central column onto the base. Before fastening the turnstile to the ground, lay the cable inside the central column (see drawing). Note: apply the ferrite to the command / accessories cables

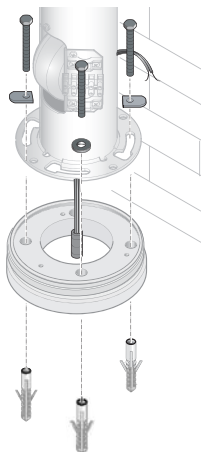
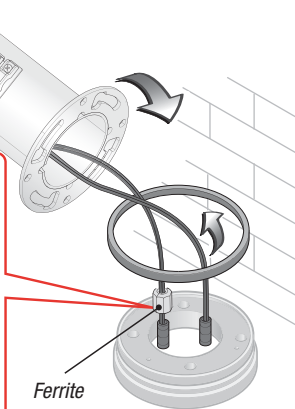
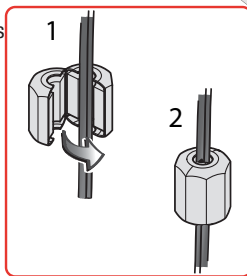
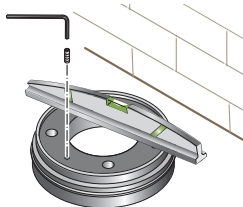

Fasten column and base to the floor using suitable screws, slide rings and UNI6593 M8 washers.

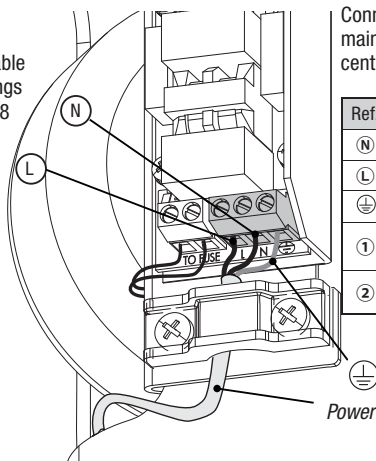

Connect the 230 V AC power mains to the terminal in the central column.

Ref.	Description
(N)	Neutral
(L)	line
(⊕)	Ground
①	230 V AC transformer (red cable)
②	120 V AC transformer (black cable)

230V AC MAINS POWER SUPPLY
(Factory configuration)

120V AC MAINS POWER SUPPLY
(Invert cables 1 and 2 as shown)

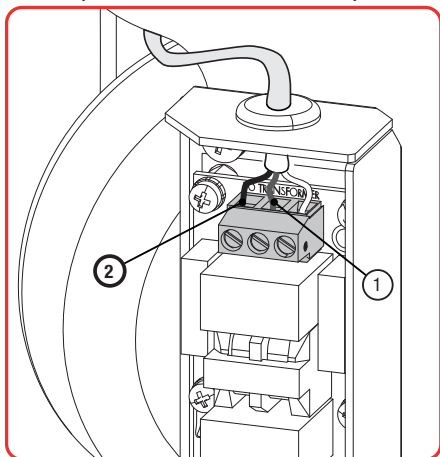
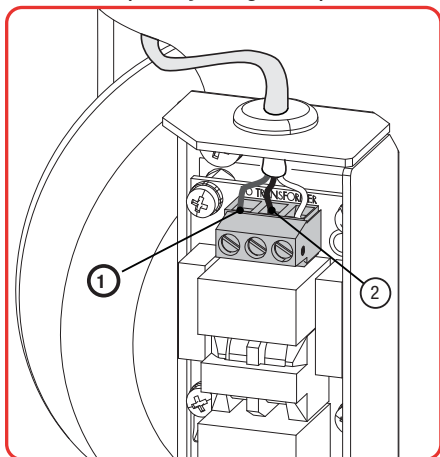

Adjusting the limit switch

Fit the wing-barrier to the drive shaft to check the position of the endstops.

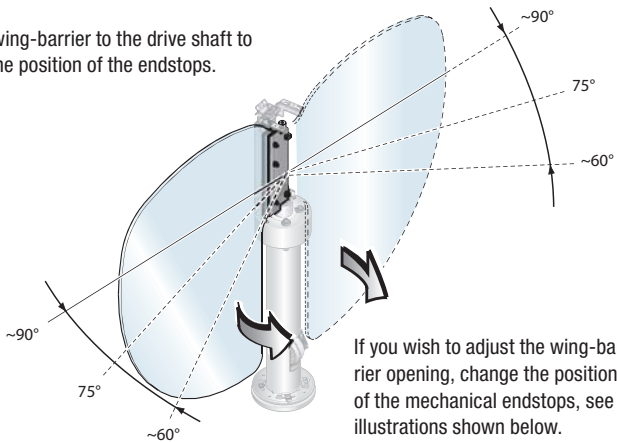
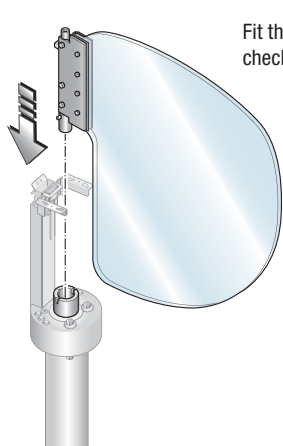

If you wish to adjust the wing-barrier opening, change the position of the mechanical endstops, see illustrations shown below.

The default position of the endstops is at 90°.

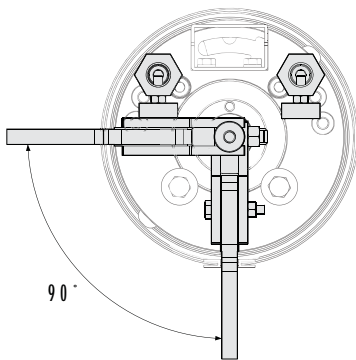
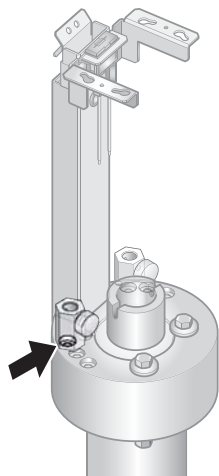

You can also have openings which are less than 90° arcs (up to 60°) by doing the following:

- A = Leaf opening at 90° (default position).
- B = Leaf opening at 75°.
- C = Leaf opening at 60°.

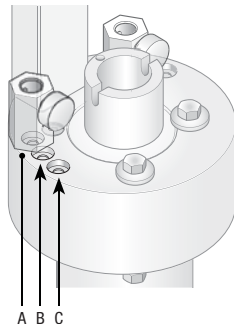

Example 60° opening arc.

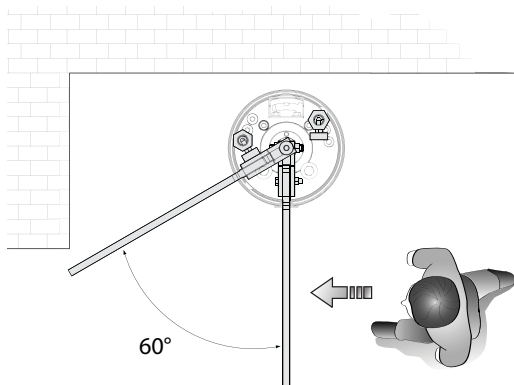

Loosen the buffer and completely loosen the screw.

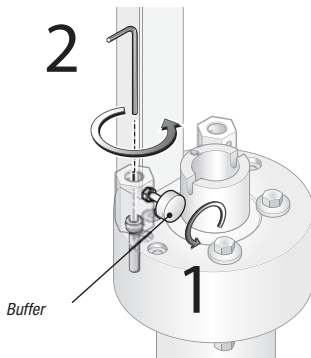

Choose the right position for positioning the limit switches (in this case, position C)

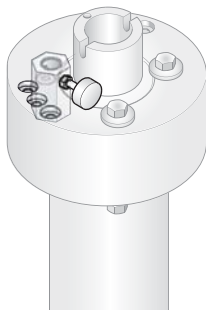

Fit the screw and turn it just enough so the support will turn.

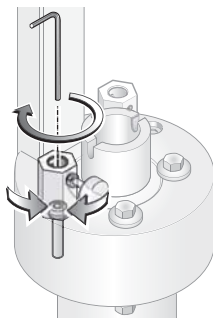

Re-tighten the buffer.

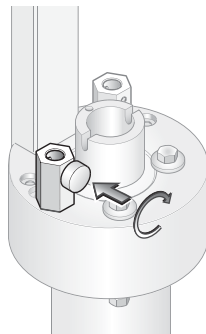

Rest the leaf against the buffer.

△ Position the limit switch so that the buffer is perfectly parallel and resting against the leaf.

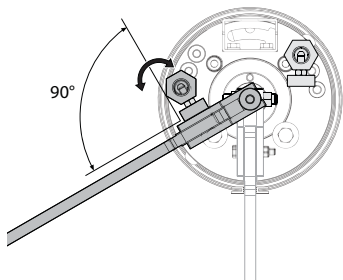

Remove the leaf from the buffer, loosen the buffer, tighten the screw and re-tighten the buffer.

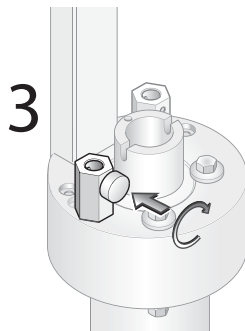
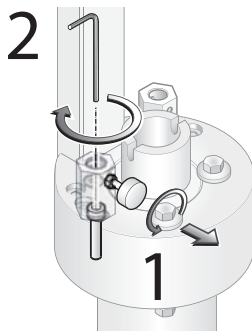

FINE TUNING THE ENDSTOP POINT

If the tuning is not enough, you can further adjust the position of the strike by fine-tuning the wing-barrier's position by removing the nut, or, loosening the buffer as shown below.

△ Also for this adjustment, you will need to perform the operation explained above.

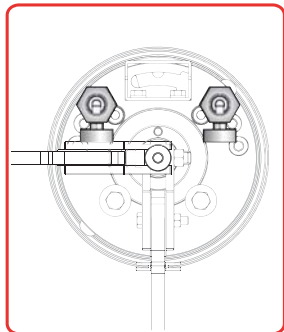
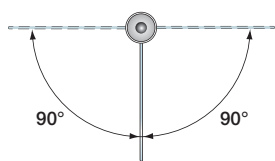

Standard position

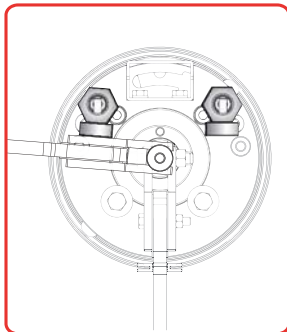
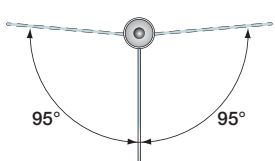

Position of the buffer without nut

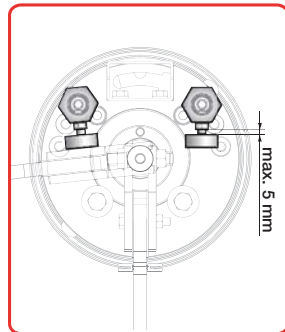
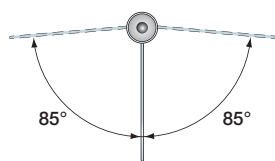

Position of the buffer loosened by about 5 mm

Fastening the leaf

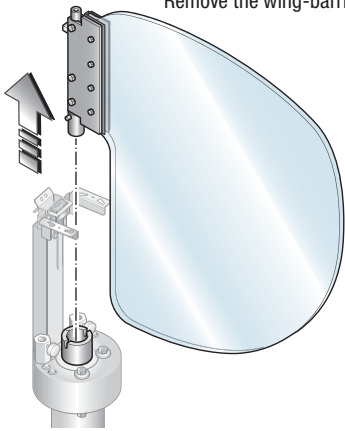

Remove the wing-barrier.

Position the drive shaft as shown in drawing A.

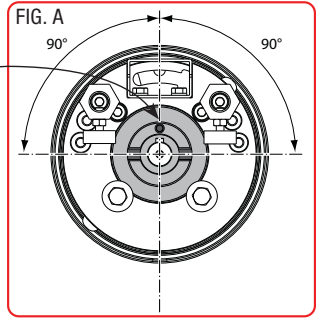
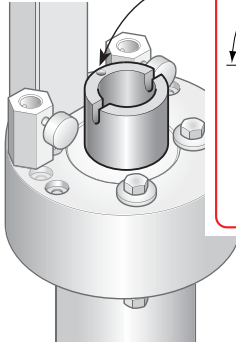

Distribute the electrical cables inside the cable passing tube.
Insert the tube.
Reinsert the wing-barrier onto the drive shaft.

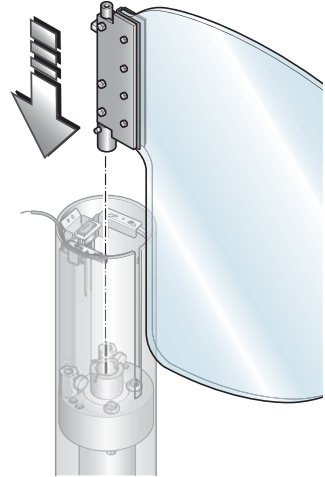
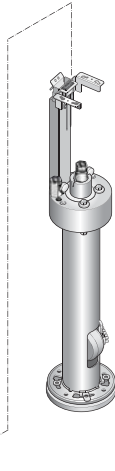
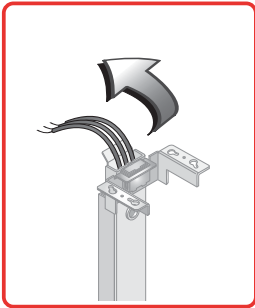

Insert the rod to fasten the wing-barrier to the transmission shaft.

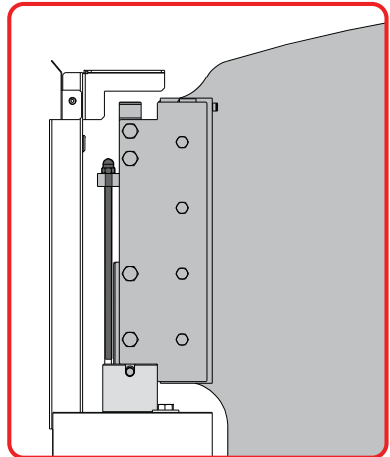
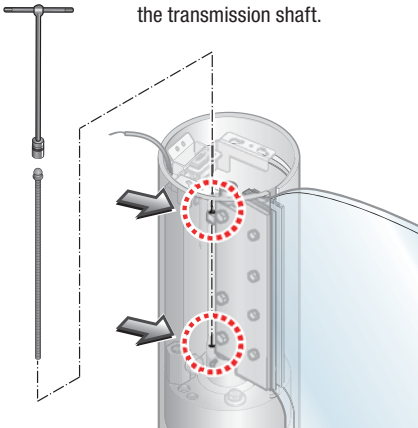

Fitting the upper cap

Insert the centering pin.

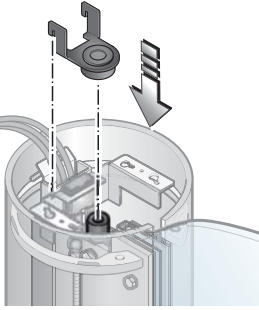

Insert and fasten the drag plate onto the tube ring.

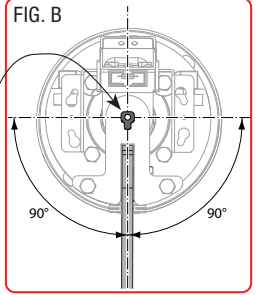
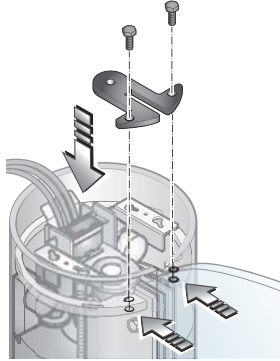

Tighten the lock extender above the plate, position and fasten the hooking bracket above the extender, see figure B.

ENGLISH

Position the electronic control board's support above the support bracket, only after passing the electric cables through the hole in the support.

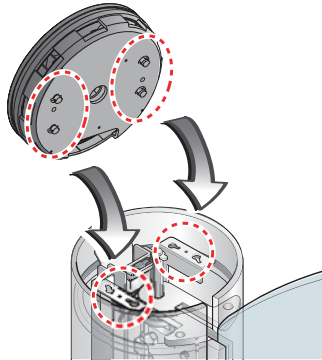

Hook up the electronic control board's support by slightly turning it clockwise.

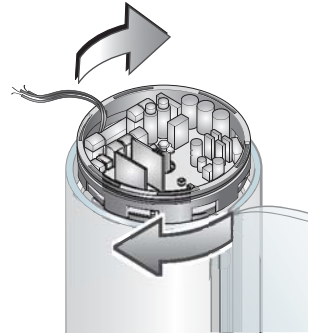
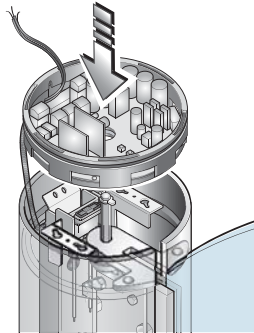

Insert the deflector as shown in the drawing.

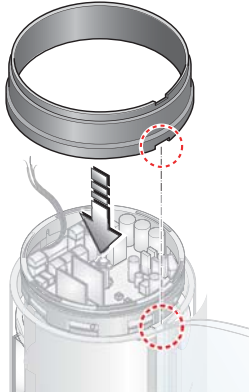

Insert the cover and fasten it with the lock by turning the key counter clockwise.

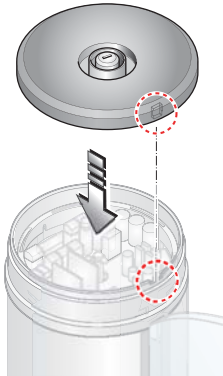

Finally, insert the cap.

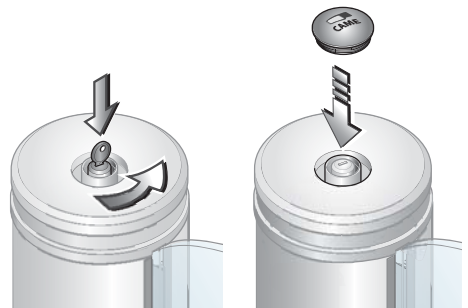

Command and control electronics

Description

The electronic board is powered by 24 V AC.

the command devices and accessories are powered by 24 V. The accessories must not exceed 10 W overall.

All connections are protected by quick fuses.

The functions on the entry and exit contacts, the time settings and user management, are all set and viewable on the display which is managed by dedicated software.

⚠ Warning! Before acting on the control panel, cut off the power supply.

FUSE TABLE

Line fuse	1.6 1.6 A-F (230 V) 3.15 3.15 A-F (120 V)
Accessories fuse	1 A-F
Control unit fuse	1 A-F

Main component parts

1. Programming buttons
2. Programming indicator LED
3. Memory roll card connector
4. R700 board connector for the first command device
5. R700 board connector for the second command device
6. Display
7. Terminals for control devices or coupled connections
8. Warning device terminals
9. LED luminous band connector
10. Transponder terminals
11. Command devices terminals
12. Accessories power supply terminals
13. Board power supply terminals
14. Accessories fuse
15. Card fuse
16. Motor/encoder connector
17. Voltage present LED warning light
18. Line fuse

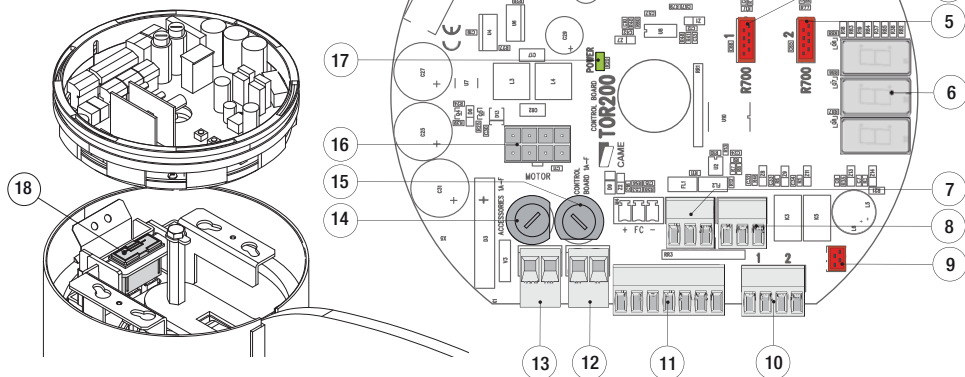

LED signal light

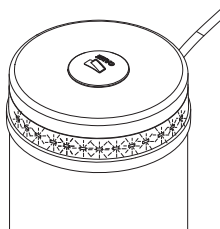

Green LED	☀ Flashing	Opening Turnstile leaf/ves
	☀ Stays on permanently	Stand-by
Red LED	☀ Slow flashing	Closing wing barrier/s
	☀ Quick flashing	Pre-flashing time before the wing-barrier/s closing phase Emergency stop button (N.C. contact)
Blue LED light	☀ Flashing	Automatic closing time

Electrical connections

Power supplies

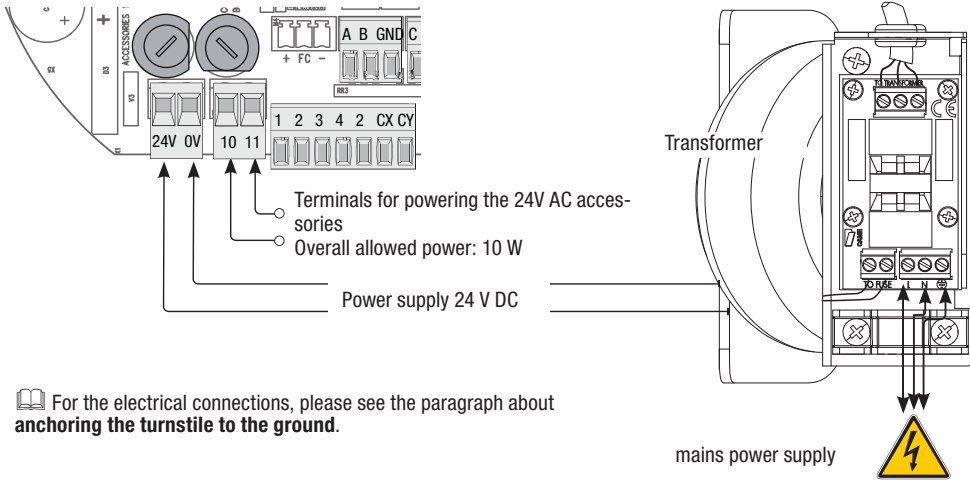

For the electrical connections, please see the paragraph about **anchoring the turnstile to the ground**.

Warning devices

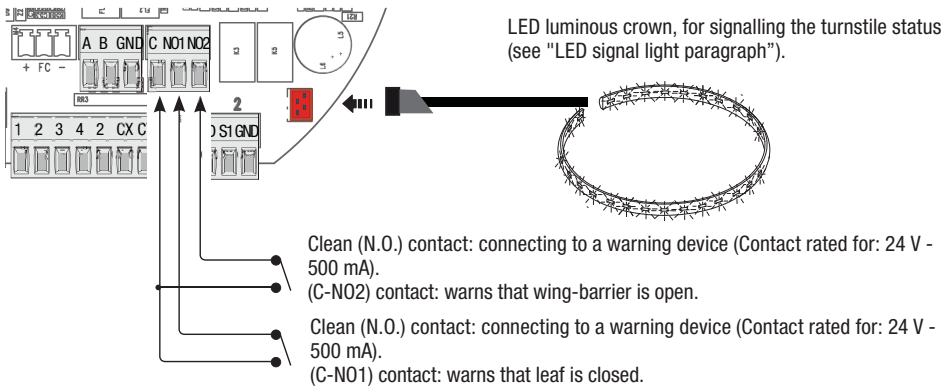

Control devices

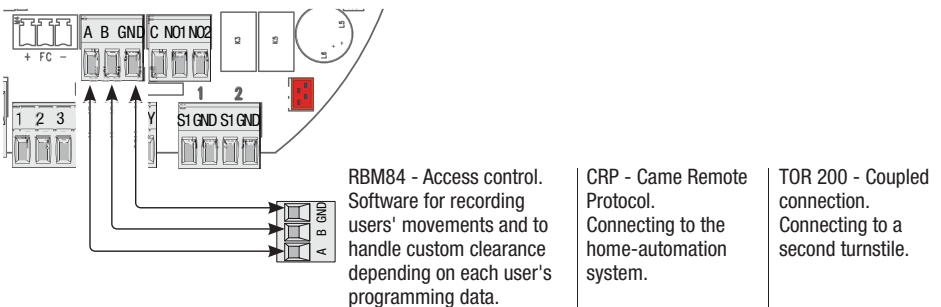

Gearmotor with encoder

24 V DC gearmotor with encoder

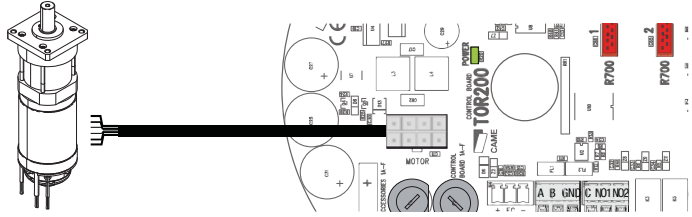

Command devices

Stop button (N.C. contact). Turnstile stop button that excludes the automatic closing cycle, to resume movement use the command device.

N.B.: if contact is unused, select 0 (Deactivated) from the F 1 function.

Opening device (N.O. contact)

Closing device (N.O. contact)

Note: if feature F 54 is set on 2, the device commands the opening wing-barrier on the side opposite that of contact 2-3.

Reopening when **closing (N.C.) Contact**

Input for safety devices like photocells, compliant with law EN 12978. During the wing-barrier opening, opening the contact will invert the movement. The wing-barrier will open completely.

(N.C.) contact **reopen while closing**

Input for safety devices like photocells, compliant with law EN 12978. During the wing-barrier opening, opening the contact will invert the movement. The wing-barrier will open completely.

(N.O.) Contact of the first command device **SENSOR 1** (Transponder or card reader with R700 board)

(N.O.) contact of the second command device **SENSOR 2** (Transponder or card reader with R700 board)

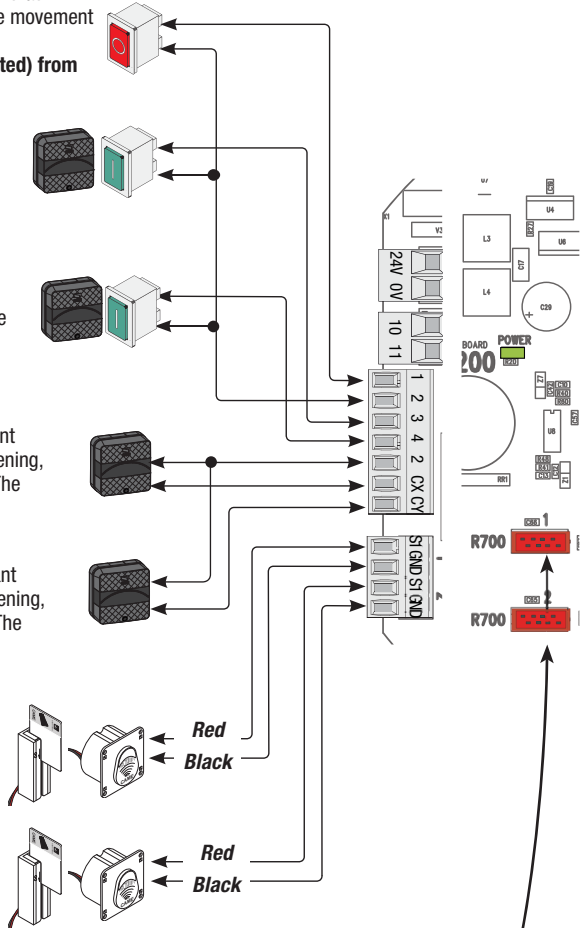

N.B.: plug in the (R700) coding card for the (TSP00) sensor or the (LT001) card reader to be recognised.

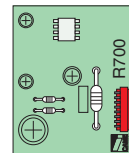

Programming

Memorising data

When using transponders or card readers, fit the R700 board
Fit the memory roll to save and load registered users onto another board.

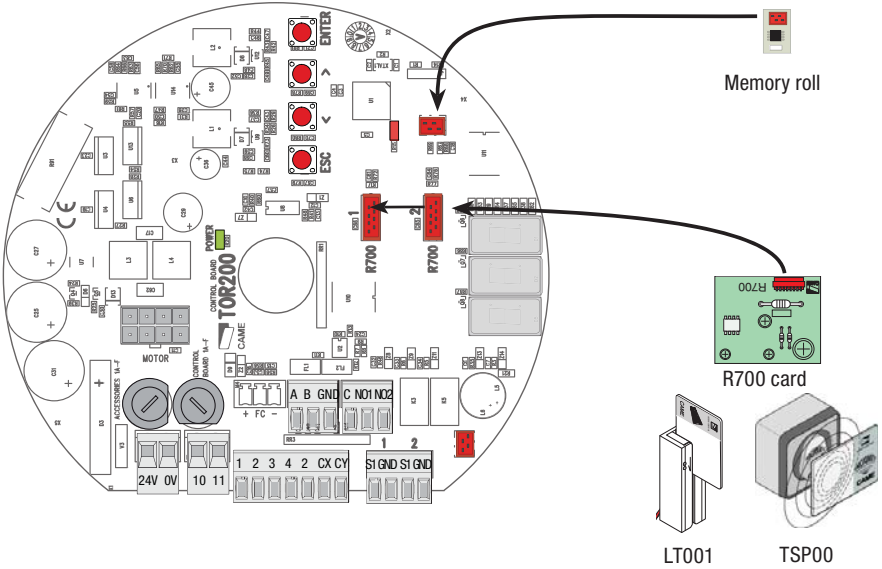

Description of programming commands

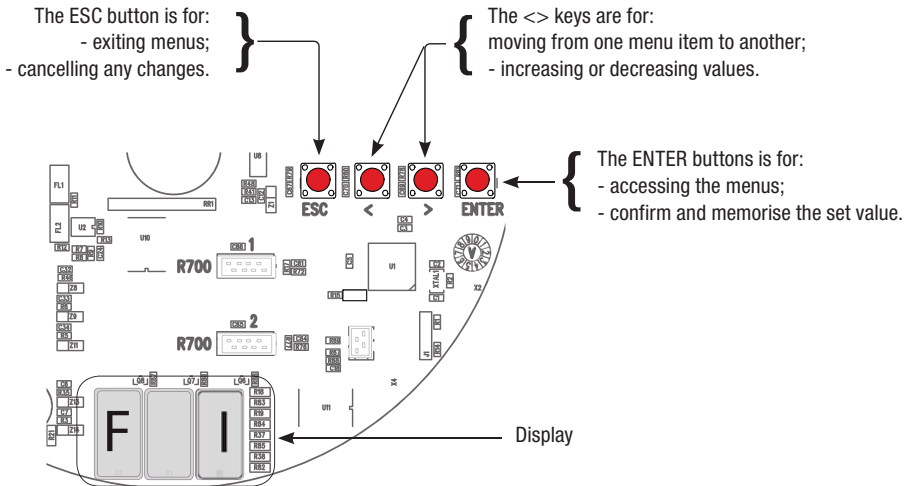

Menu map

F 1	Total stop function (1-2)
F 2	Function associated to input 2-CX
F 3	Function associated to input 2-CY
F 19	Automatic closing time
F 21	Pre-flashing time
F 28	Adjusting opening speed
F 29	Adjusting the closing speed
F 30	Adjusting the slow-down speed when opening
F 31	Adjusting closing-slow-down speed
F 33	Adjusting calibration speed
F 34	Sensitivity during movement
F 35	Sensitivity during slow down
F 37	Adjusting the beginning slow-down point of the motor when opening
F 38	Adjusting the beginning slow-down point of the motor when closing
F 39	Adjusting the beginning opening strike point of the motor
F 40	Adjusting the beginning closing strike point of the motor
F 49	Combo connection functions
F 50	Saving data in the memory roll
F 51	Reading memory roll data
F 52	Passing parameters from MASTER TO SLAVE
F 53	Anti-Pass-Back function
F 54	Direction choice function associated to the Anti-pass-back function
F 55	Alarm activation function
F 56	Setting the number of the peripheral
F 57	Limit-switch closing offset functions
U 1	Adding a new user
U 2	Cancelling one user
U 3	Completely cancel users
A 1	Leaf type
A 2	Motor testand
A 3	Calibrating travel
A 4	Reset parameters
H 1	Software version

Motor test and calibration menu

Important! We suggest starting the programming by first doing the following:

1 Defining the wing-barrier type;

2 Motor test;

3 Calibration of travel.

Confirm with the ENTER button after choosing the value for each feature.

A 1 (Wing barrier type): defining the wing barrier.

Note: the choice of wing-barrier type limits some parameters in terms of speed, end strikes, and the such. This ensures the proper functioning of the operator.

1 = glass leaf (default); 2= Plexiglas leaf.

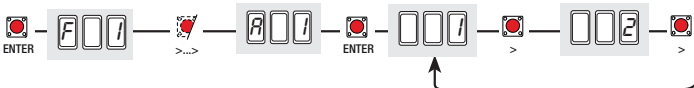

A 2 (Motor test): activate the test to check whether the turnstile works properly (see the paragraph about **motor test**).

0 = Deactivated; 1 = Activated.

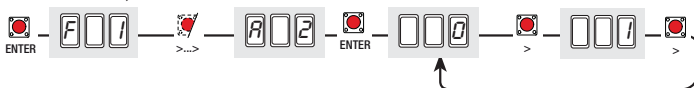

A 3 (travel calibration): automatic gate-wing travel calibrating operation (see the paragraph about **calibrating travel**).
 0 = Deactivated; 1 = Activated.

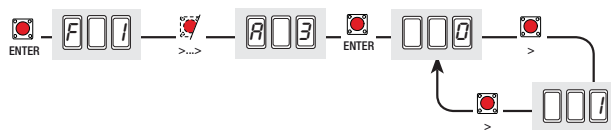

Warning! If needed, you can restore the factory settings with the following feature:

A 4 (Reset parameters): data restoring procedure (for default settings) and travel calibration cancellation.
 0 = Deactivated; 1 = Activated.

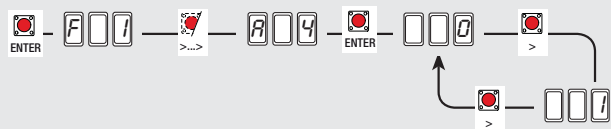

Features menu

F 1 (Total Stop 1-2) - N.C. input: wing-barrier stop with possible exclusion of the automatic-closing cycle; to restore movement act on the command device. Insert safety device on [1-C2]; if unused, set the feature to 0.
 0 =Deactivated (default) 1 = Activated

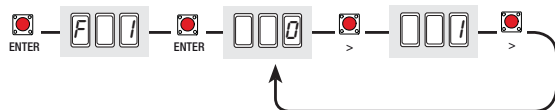

F 2 (2-CX input): N.C. safety contact input (reopen while closing).
 0 = deactivated (**default**); 1 = Activated.

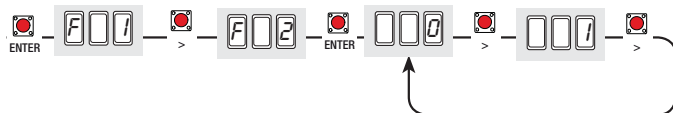

F 3 (2-CY input): N.C. safety contact input (reopen while closing).
 0 = deactivated (**default**); 1 = Activated.

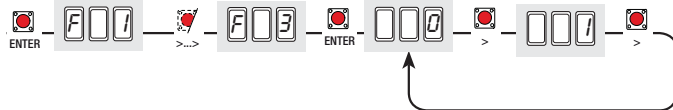

F 19 (Automatic closing time): the automatic closing timer activates at the closing endpoint. The pre-set time is adjustable, and is anyhow conditioned by a possible intervention by the safety devices and is deactivated after a total emergency stop or when the power is cut.

The waiting time can be deactivated or adjusted from 1" to 60".
 1 = 1 second (**default**); 2 = 2 seconds; 60 = 60 seconds.

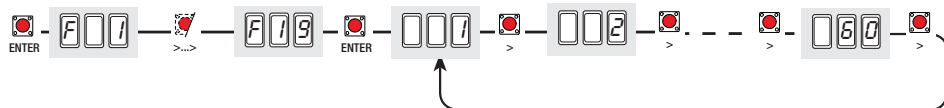

F 21 (Pre-flashing time): after a closing command, the LED luminous crow connected to the electronic card, flashes for an adjustable span of time before starting its travel.

the pre-flashing time can be deactivated or adjusted from 1" to 5".

0 = Deactivated (**default**); 1 = 1 second; 2 = 2 seconds; 5 = 5 seconds.

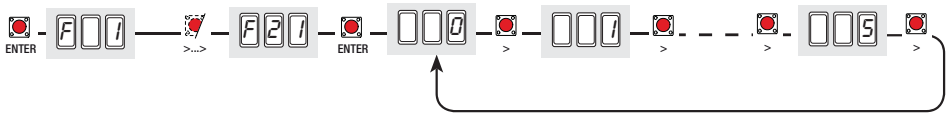

F 28 (Opening travel-speed): setting the opening travel-speed, calculated as a percentage.

40 = 40% of the motor speed (minimum); 100 = 100% of the motor speed (maximum).

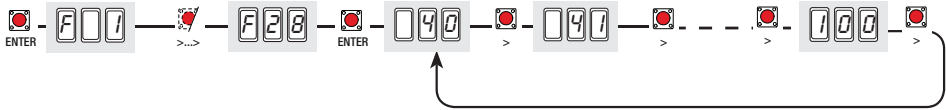

F 29 (Closing travel-speed): setting the closing travel-speed, calculated as a percentage.

40 = 40% of the motor speed (minimum); 80 = 80% of the motor speed (maximum).

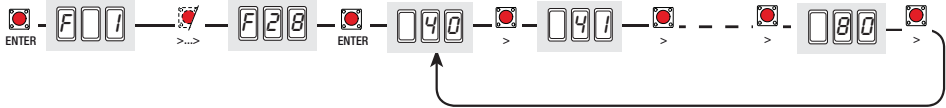

F 30 (Opening slow-down speed): setting the opening slow-down-speed, calculated as a percentage.

20 = 20% motor slow-down speed (minimum); 30 = 30% motor slow-down speed (maximum).

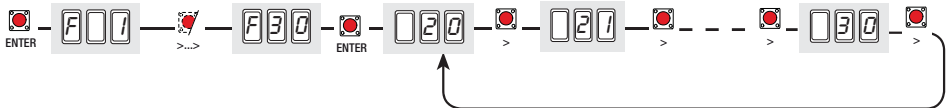

F 31 (closing slow down speed): setting the speed for closing slow-down, calculated as a percentage.

20 = 20% motor slow-down speed (minimum); 30 = 30% motor slow-down speed (maximum).

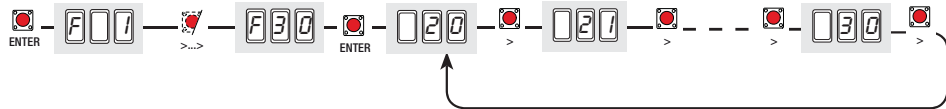

F 33 (Calibration speed): setting the speed only during the wing-barrier's calibration phase, calculated as a percentage.

20 = 20% of the motor speed; 30 = 30% of the motor speed.

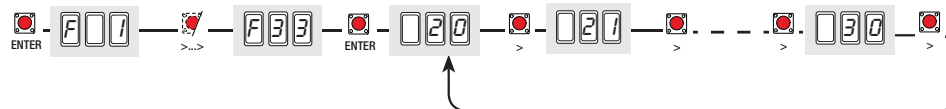

F 34 (travel sensitivity): adjusts the obstacle-detection sensitivity during travel.

10 = maximum sensitivity; 100 = minimum sensitivity (default).

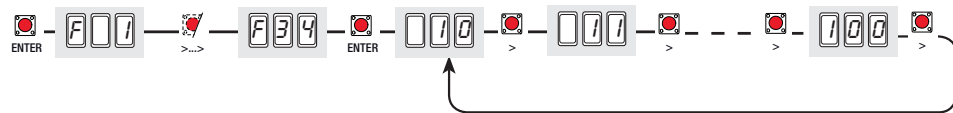

F 35 (Slow-down sensitivity): adjusts the obstacle detection sensitivity when slowing-down.

10 = maximum sensitivity; 100 = minimum sensitivity (default).

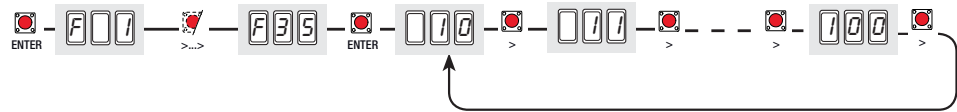

F 37 (Motor opening slow-down point): adjusts the motor's beginning slow-down point before the opening endstop.

The slow-down starting point is calculated in degrees.

10 = 10°; 45 = 45°.

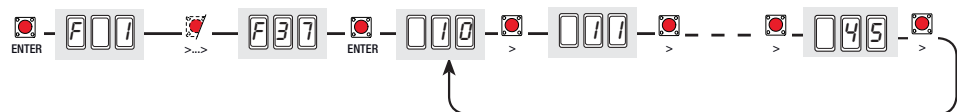

F 38 (Motor closing slow-down point): adjusts the motor's beginning point of slow-down before the closing endstop.

The slow-down starting point is calculated in degrees.

10 = 10°; 45 = 45°.

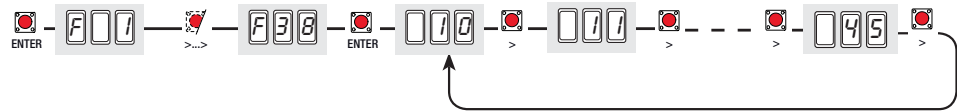

F 39 (Opening approach point): adjusts the starting point of the approaching area of the opening endstop.

The area is calculated in degrees.

0 = 0°; 5 = 5°.

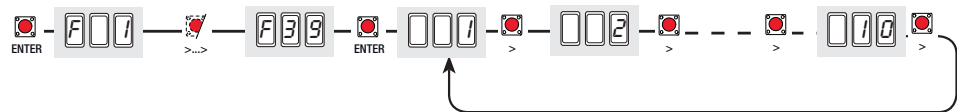

F 40 (Closing approach point): adjusts the starting point of the approaching area of the closing endstop.

The area is calculated in degrees.

0 = 0°; 5 = 5°.

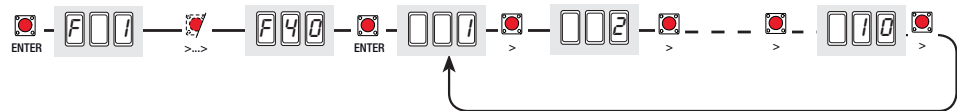

F 49 (Coupled): enabling two turnstiles to function in coupled or RBM84 modes (access control management) or CRP (Came Remote Protocol).

0 = Deactivated (**default**); 1 = Combined; 2 = RBM84; 3 = CRP.

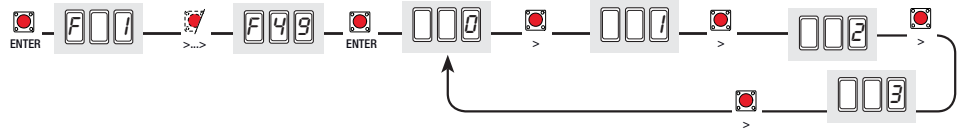

F 50 (Save data): saves users and all settings in the memory roll.

Note: this functions works only is the memory roll is fitted to the electronic control board.

0 = Deactivated; 1 = Activated

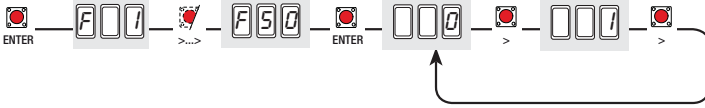

F 51 (Data reading): for loading memory roll data onto the electronic control board.

Note: this function appears on if after you fitting the memory roll onto the electronic board.

0 = Deactivated; 1 = Activated.

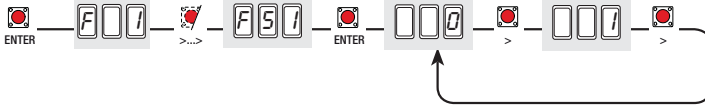

F 52 (Passing parameters): function for load the parameters from Master to Slave. The parameters are:

- opening and closing speeds;
- opening and closing slow-down speeds;
- opening and closing slow-down points;
- slow-down and travel sensitivity;
- calibration speed.

Note: this function appears on if function F49 is set to **combined connection**.

0 = Deactivated; 1 = Activated.

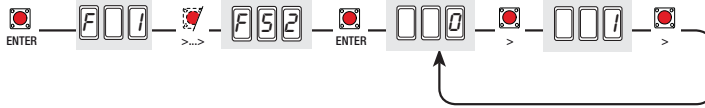

F 53 (Antipassback): prevents access to an area when the person is already inside. Can be used to avoid using one card for two or more consecutive accesses in the same area; for example a gym, to prevent clients from entering with the personal card of someone who has already entered.

0 = Deactivated; 1 = Activated;

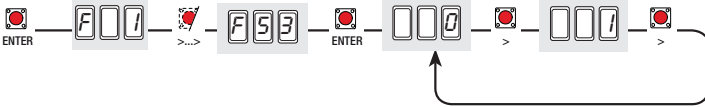

F 54 (Entry direction): setting the entry direction.

0 = Counter-clockwise (default); 1 = Clockwise; 2 = Both directions;

Note: if the feature is set to 2 **both directions**, the (2-4) contact operates the opens wing-barrier in the direction opposite that of contact (2-3).

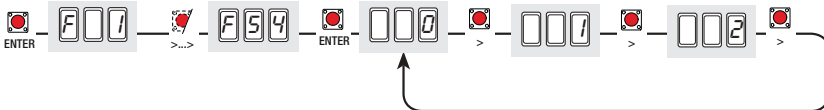

F 55 (Alarm): setting the alarm activation time. It activates when contacts 2-CX and 2-CY are opened with wing-barrier/s closed or during the pre-flashing phase set on F 21.

The time can be adjusted from between 1" to 60".

0 = Deactivated (**default**); 1 = 1 second; 60 = 60 seconds.

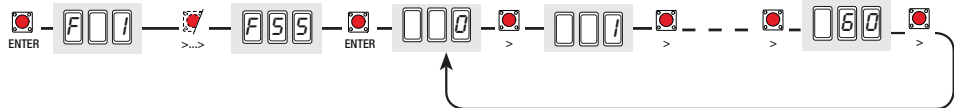

F 56 (Peripheral number): when installing multiple turnstiles, set the peripheral number from 1 to 255 for each electronic card.

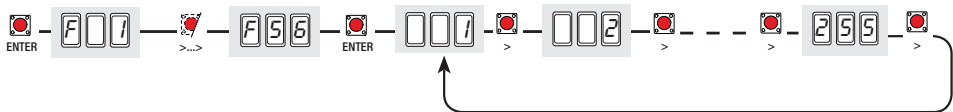

F 57 (Regulate position of closed wing barrier): for adjusting the closing limit-switch compensation point on systems with curved entrances (see the paragraph about **Closing limit-switch offset**). The compensation point is calculated in degrees between -45° and 45°.

-45 = -45°; 0 = Deactivated (**default**); 45 = 45°.

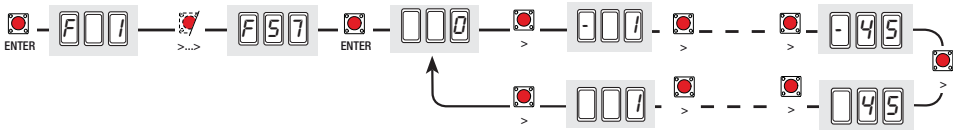

Users menu

U 1 (Registering users): entering 150 users max.) via the transponder card (see paragraph about **adding users**)
0 = Deactivated; 1 = Activated

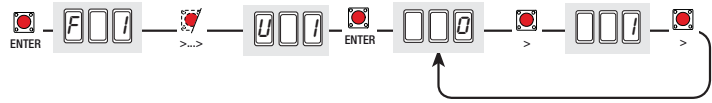

U 2 (Cancelling users): cancelling single users (see paragraph on **cancelling single users**).

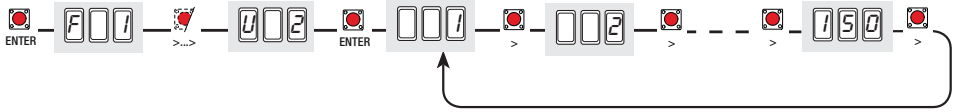

U 3 (Cancelling users): cancelling all users on memory. Press Enter button to confirm cancellation
0 = Deactivated; 1 = Cancelling all users

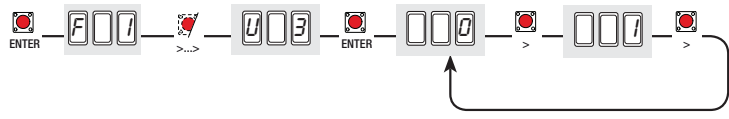

Info menu

H 1 (Version): view software version.



Motors test

Select A 2. Press ENTER to confirm.

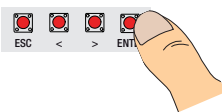

Select 1 to activate the test. Press ENTER to confirm.

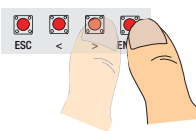
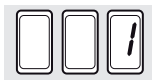

Will appear, meaning it is standing by for a command.



Keep pressed the button indicated by the > arrow and check that the wing barrier completes a clockwise movement.

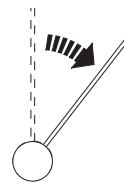
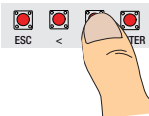

Do the same procedure using the button indicated by the > arrow to check that the wing barrier completes an anti-clockwise movement.

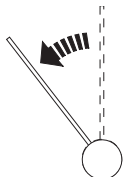
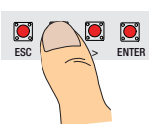

Closing limit-switch offset

After positioning the mechanical stops and calibrating the travel, the Offset closing endstop operation is for balancing the closing angle on curved entrance systems.

Select F 57 Press ENTER to confirm.

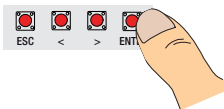

Press the arrow button > to compensate the end-stop closes counter clockwise.

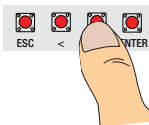
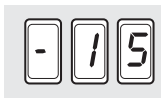

Or the arrow button < to compensate the endstop closes clockwise.

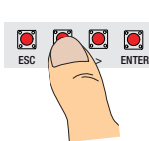
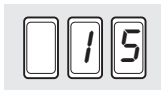

Press ENTER to confirm.

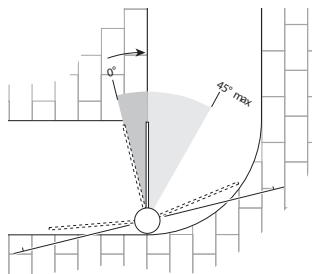
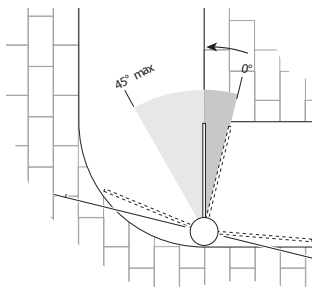
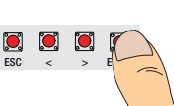

N.B.: before calibrating the travel, make sure the area about the arm is free of any obstacles. Important! While calibrating, all safety devices will be deactivated until calibration is complete, except for the TOTAL STOP.

Select A 3.
Press ENTER to confirm.



1) Select 1 and press ENTER to confirm the automatic-calibration-of-travel mode.

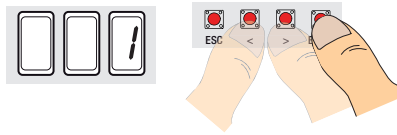

The wing-barrier will move clockwise until it reaches the mechanical stop.

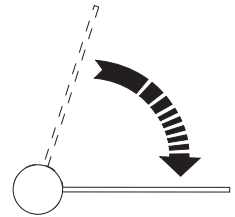

The wing-barrier will invert the movement until it reaches the mechanical stop.

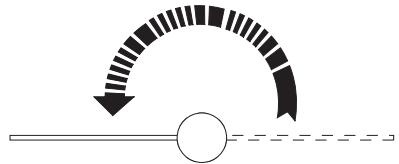

Wait a few seconds for it to be logged and displayed.



Warning! The wing-barrier's closing position bisects the opening and closing strokes.

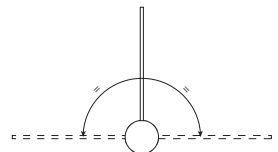

N.B.: during registering / cancelling new users operations, the flashing numbers viewed, are available and usable for any user needing to be registered (maximum).

Enter user

Select U 1.
Press ENTER to confirm.

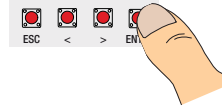

Select 1 to activate registration of one user via transponder card. Press ENTER to confirm.

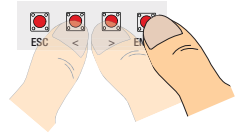

A progressive number between 1 and 150 will appear and flash for some seconds. Send the code with the transponder card or other command device, the number stays fixed for an instant to show that user registration is complete.

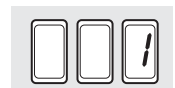
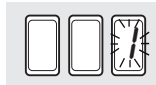

then another progressive number will appear and flash for another possible new user registration.

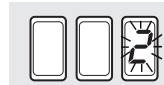

Cancelling one user

Select U 2. Press ENTER to confirm.

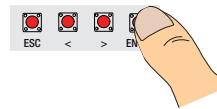

2) Use the arrow buttons to select the user number you wish to cancel. Press ENTER to confirm.

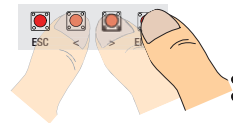

the number will flash for a few seconds, reconfirm by pressing ENTER.

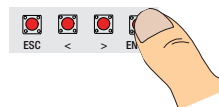

CLr will be displayed to confirm cancellation.



List of registered users

1)
2)
3)
4)
5)
6)
7)
8)
9)
10)
11)
12)
13)
14)
15)
16)
17)
18)
19)
20)
21)
22)
23)
24)
25)
26)
27)
28)
29)
30)
31)
32)
33)
34)
35)
36)
37)
38)
39)
40)
41)
42)
43)
44)
45)
46)
47)
48)
49)
50)

51)
52)
53)
54)
55)
56)
57)
58)
59)
60)
61)
62)
63)
64)
65)
66)
67)
68)
69)
70)
71)
72)
73)
74)
75)
76)
77)
78)
79)
80)
81)
82)
83)
84)
85)
86)
87)
88)
89)
90)
91)
92)
93)
94)
95)
96)
97)
98)
99)
100)

101)
102)
103)
104)
105)
106)
107)
108)
109)
110)
111)
112)
113)
114)
115)
116)
117)
118)
119)
120)
121)
122)
123)
124)
125)
126)
127)
128)
129)
130)
131)
132)
133)
134)
135)
136)
137)
138)
139)
140)
141)
142)
143)
144)
145)
146)
147)
148)
149)
150)

Combined connection

Specific connections

Connect the two (TOR 200) cards with a multi-coupling braided unshielded (CAT 5 - U/UTP -AWG 24) cable on terminals A-B-GND.

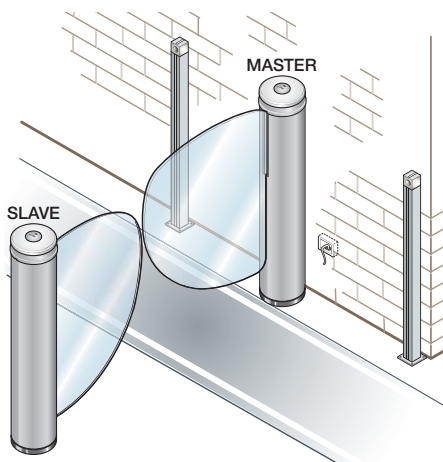
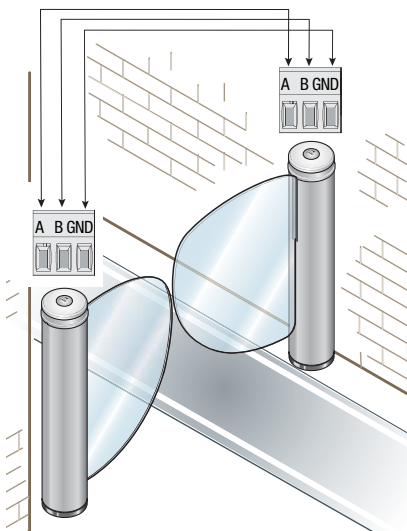

Connect all of the necessary devices on the TOR 200 card of the MASTER turnstile.

Turnstile (MASTER) settings and configuration

Set the features and adjustments only on the MASTER turnstile card.

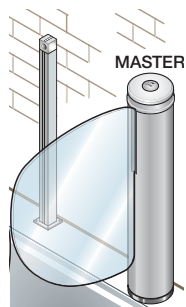

Configure the card as the MASTER. Select feature F 49 Press ENTER to confirm.

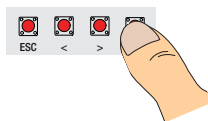

Set to 1 = combined and press Enter

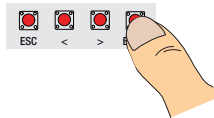

Passing parameters from MASTER TO SLAVE

To transfer the parameters from the MASTER to the SLAVE card, proceed as follows:

- select the F 52 feature on the MASTER card.

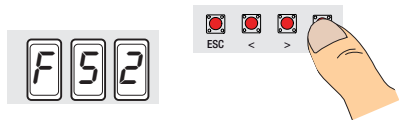

- select 1 and press ENTER.

Note: in case a system needs different parameters from those of the MASTER and SLAVE card, make the feature settings directly onto each card.

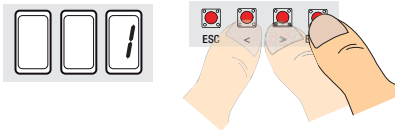

Calibrating travel

Calibrate the MASTER card
Select A 3 and press ENTER to confirm.



- 1) Select 1 and press ENTER to confirm the automatic-calibration-of-travel mode.

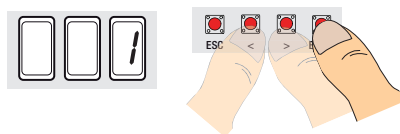

The wing-barriers will slow down their travel until the stopping strike.

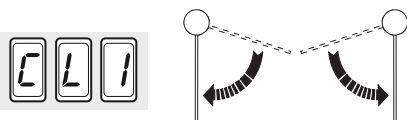

The wing-barriers will invert their travel until the stopping strike.

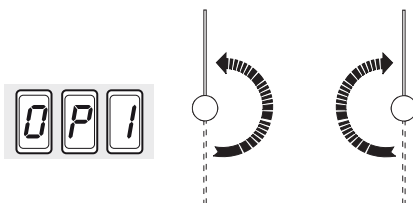

Maintenance

⚠ Before any maintenance jobs, cut off the main power, to prevent any potentially hazardous accidental movements of the device.

Periodic maintenance log to be done twice yearly by the end-users

Date	Notes	Signature

Extraordinary maintenance

⚠ The following table is used to log extraordinary maintenance, repair and improvement jobs done by the specialised contractors.

N.B.: All extraordinary maintenance jobs must be carried out by skilled technicians.

Extraordinary maintenance log

Installer's stamp	Product name
	Date of job
	Technician's signature
	Customer's signature
Job performed _____ _____	
Installer's stamp	Product name
	Date of job
	Technician's signature
	Customer's signature
Job performed _____ _____	
Installer's stamp	Product name
	Date of job
	Technician's signature
	Customer's signature
Job performed _____ _____	

Error messages and notifications

- Er3: encoder out-of-order; call for assistance.
 Er4: services test error: check proper connections and functioning state of the safety devices.
 Er5: insufficient working time; call for assistance.
 Er6: maximum number of detected obstacles
 Er7: overheating transformer, upon the first opening command,, the wing-barriers stay open.
 C0: contact 0-1 (stop) unused and not deactivated
 C1: contacts CX and/or CY unused or not deactivated
 RED flashing LED: control board is not yet calibrated for run.

Dismantling and disposal

 On its premises, CAME Cancelli Automatici S.p.A. implements a certified Environmental Management System in compliance with the UNI EN ISO 14001 standard to ensure environmental protection. Please help us to safeguard the environment. At CAME we believe this to be one of the fundamentals of our operational and market development strategies. Just follow these short disposal instructions:

DISPOSING OF THE PACKAGING

The components of the packaging (i.e. cardboard, plastic, etc.) are household waste and may be disposed of without much trouble, simply by separating them for recycling.

Before proceeding it is always a good idea to check your local legislation on the matter.

DISPOSE OF CAREFULLY!

PRODUCT DISPOSAL

Our products are made up of various materials. The majority of these (aluminium, plastic, iron, electrical wires) is household waste. These can be disposed of at local solid waste management dumps or recycling plants.

Other components (i.e. control boards, transmitter batteries, etc.) may contain hazardous substances.

These must therefore be handed over to specially authorised disposal firms.

Before proceeding it is always a good idea to check your local legislation on the matter.

DISPOSE OF CAREFULLY!

Declaration of conformity

Declaration CE - Came Cancelli Automatici S.p.A. declares that this device complies with the essential requirements and other relevant provisions established in Directives 2006/42/CE, 2006/195/CE and 2004/108/CE.

Reference code for requesting a true copy: DDC L 0002



English - Manual code: **11963565EN** - ver. **3** 07/2013 © CAME Cancelli Automatici S.p.A.
The data and information in this manual may be changed at any time and without obligation on the part of CAME Cancelli Automatici S.p.A. to notify said changes.

EN • For any further information on company, products and assistance in your language:



CAMEGROUP

CAME Cancelli Automatici S.p.a.

Via Martiri Della Libertà, 15

31030 **Dossón Di Casier** (Tv)

☎ (+39) 0422 4940

☎ (+39) 0422 4941

Assistenza Tecnica/Numero Verde 800 295830